

PROFIX CONCEALED FLAT STICK INSTALLATION - PROBOND FACADE FR

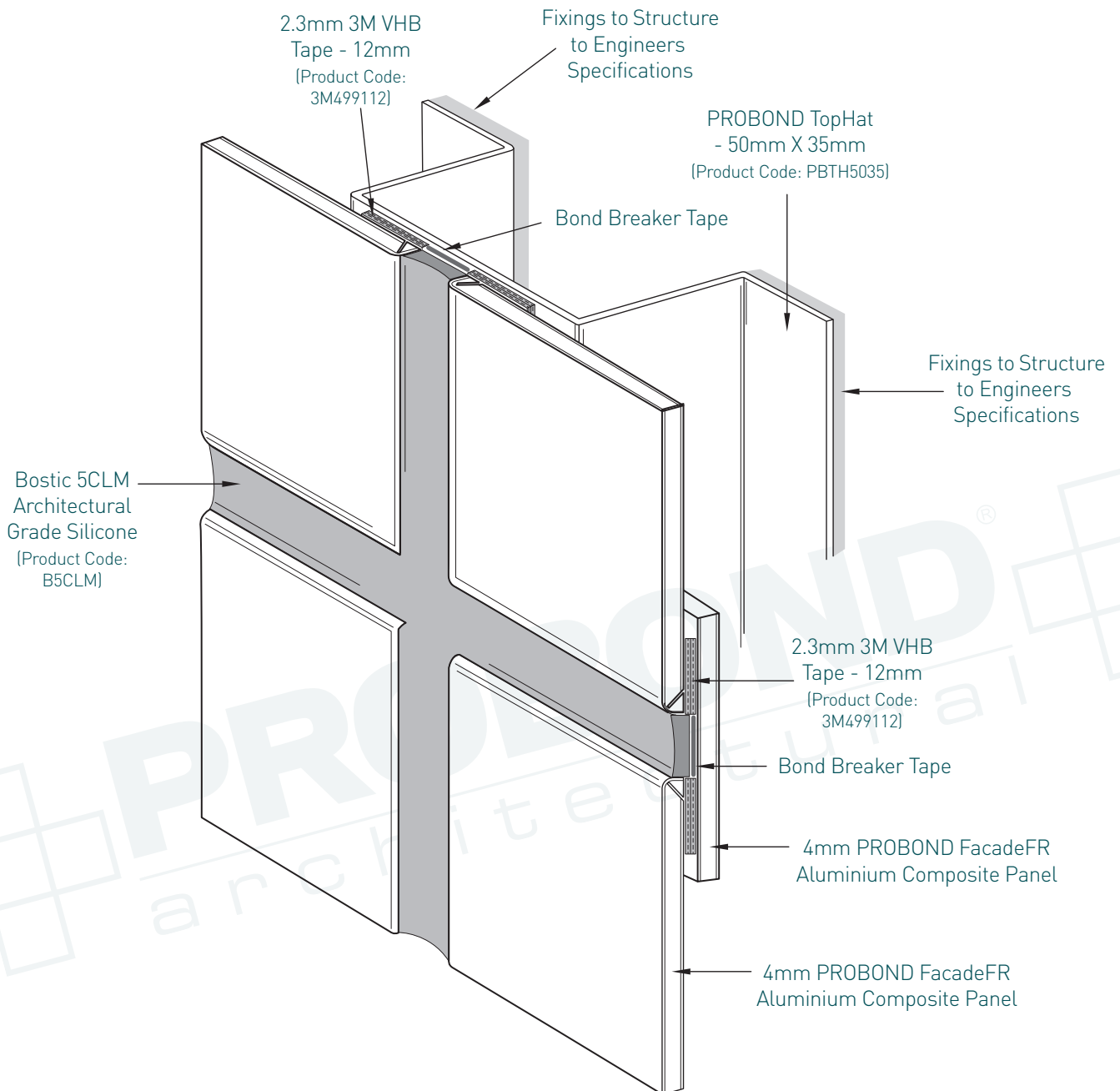

1. Face Detail - Concealed Flat Stick Installation

PROFIX CONCEALED FLAT STICK INSTALLATION - PROBOND FACADE FR

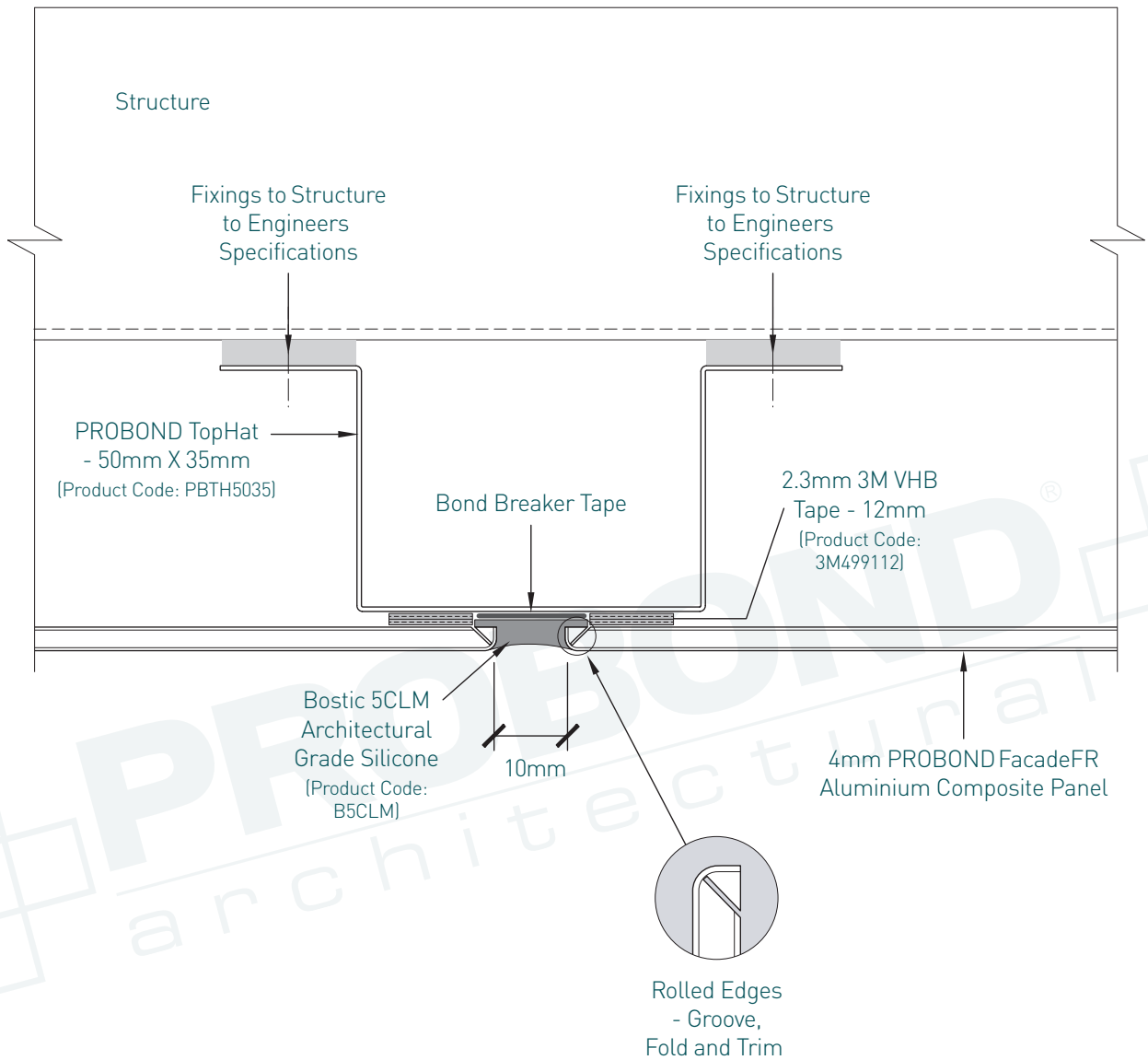

2. Typical Panel Joint Detail

PROFIX CONCEALED FLAT STICK INSTALLATION - PROBOND FACADE FR

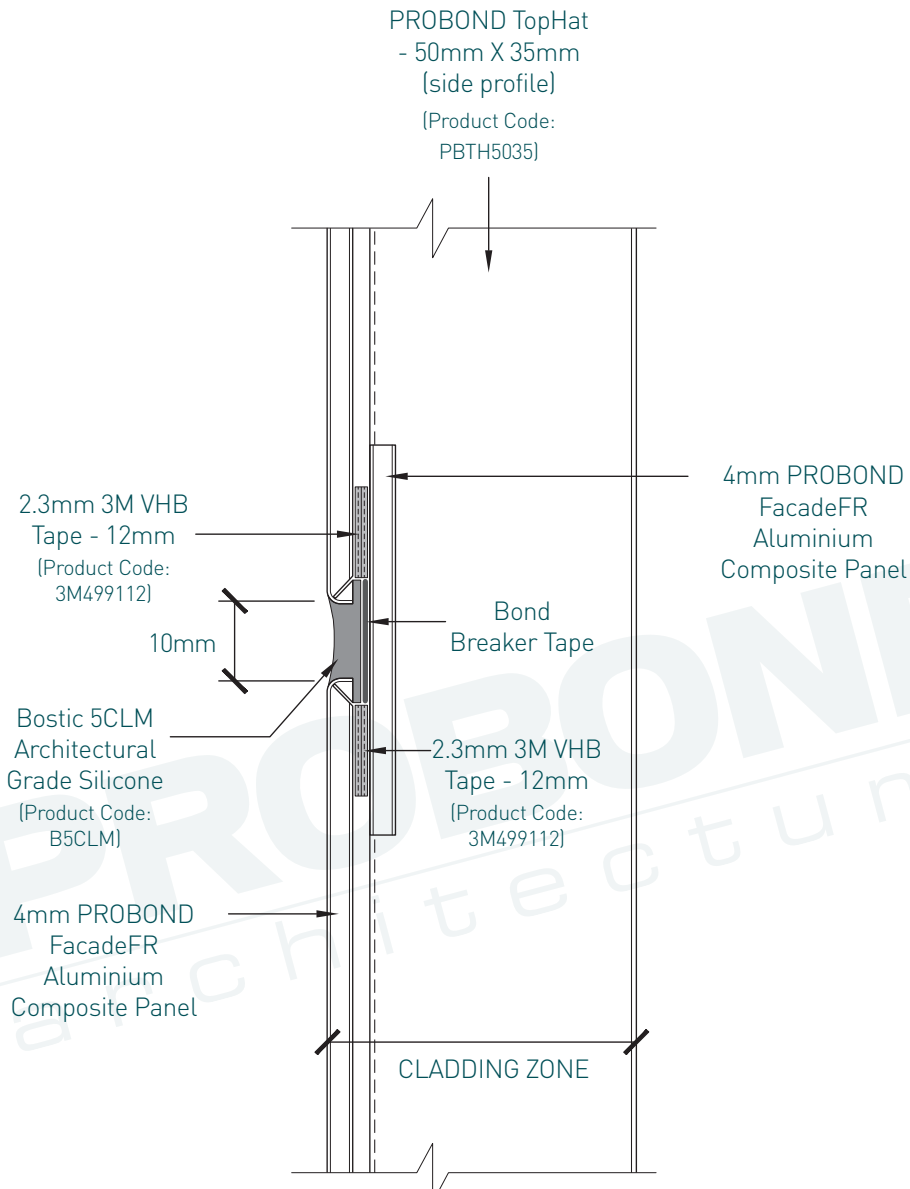

3. Horizontal Joint Detail

PROFIX CONCEALED FLAT STICK INSTALLATION - PROBOND FACADE FR

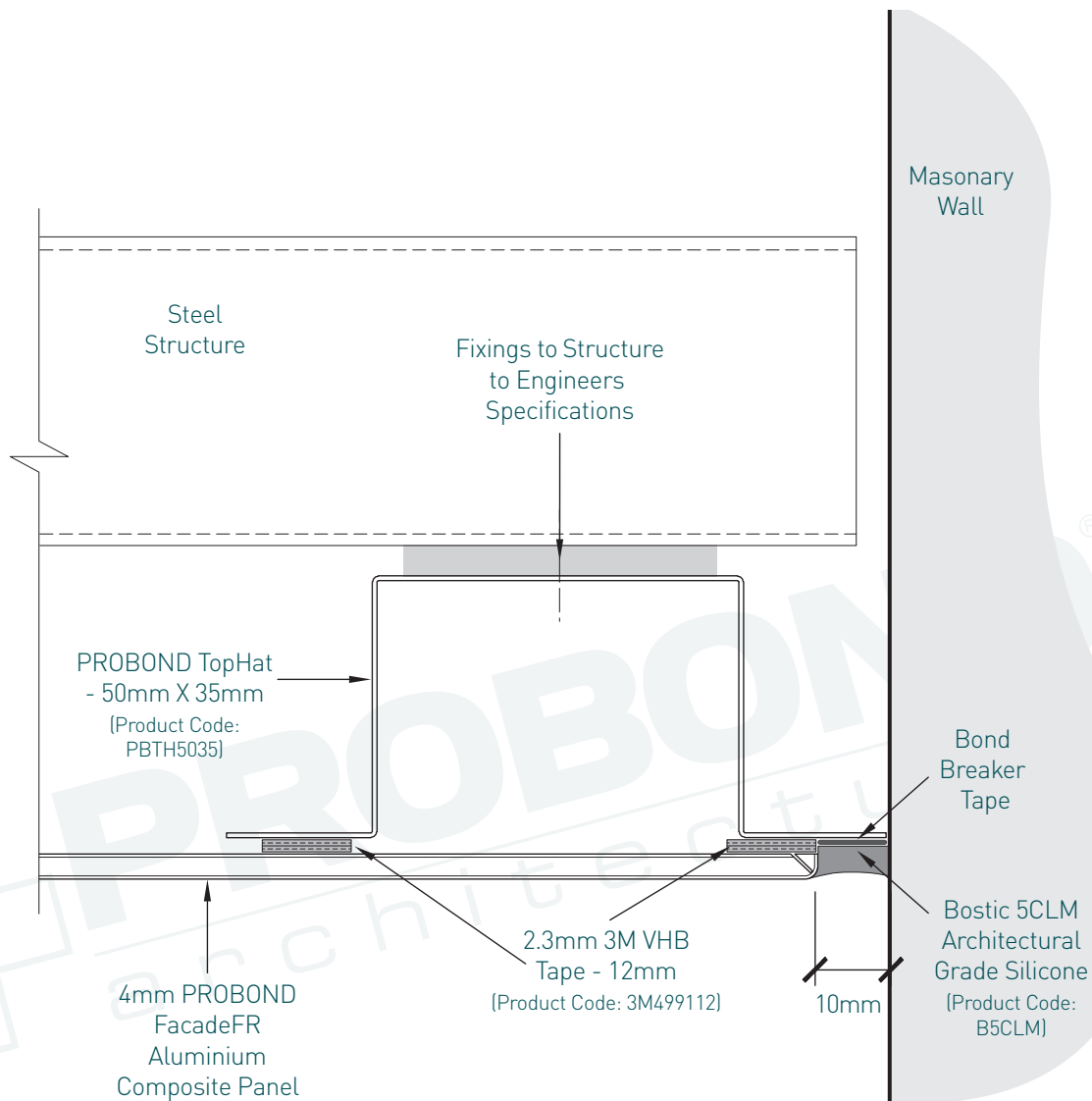

4. Detail Showing Panel at Masonry Wall

PROFIX CONCEALED FLAT STICK INSTALLATION - PROBOND FACADE FR

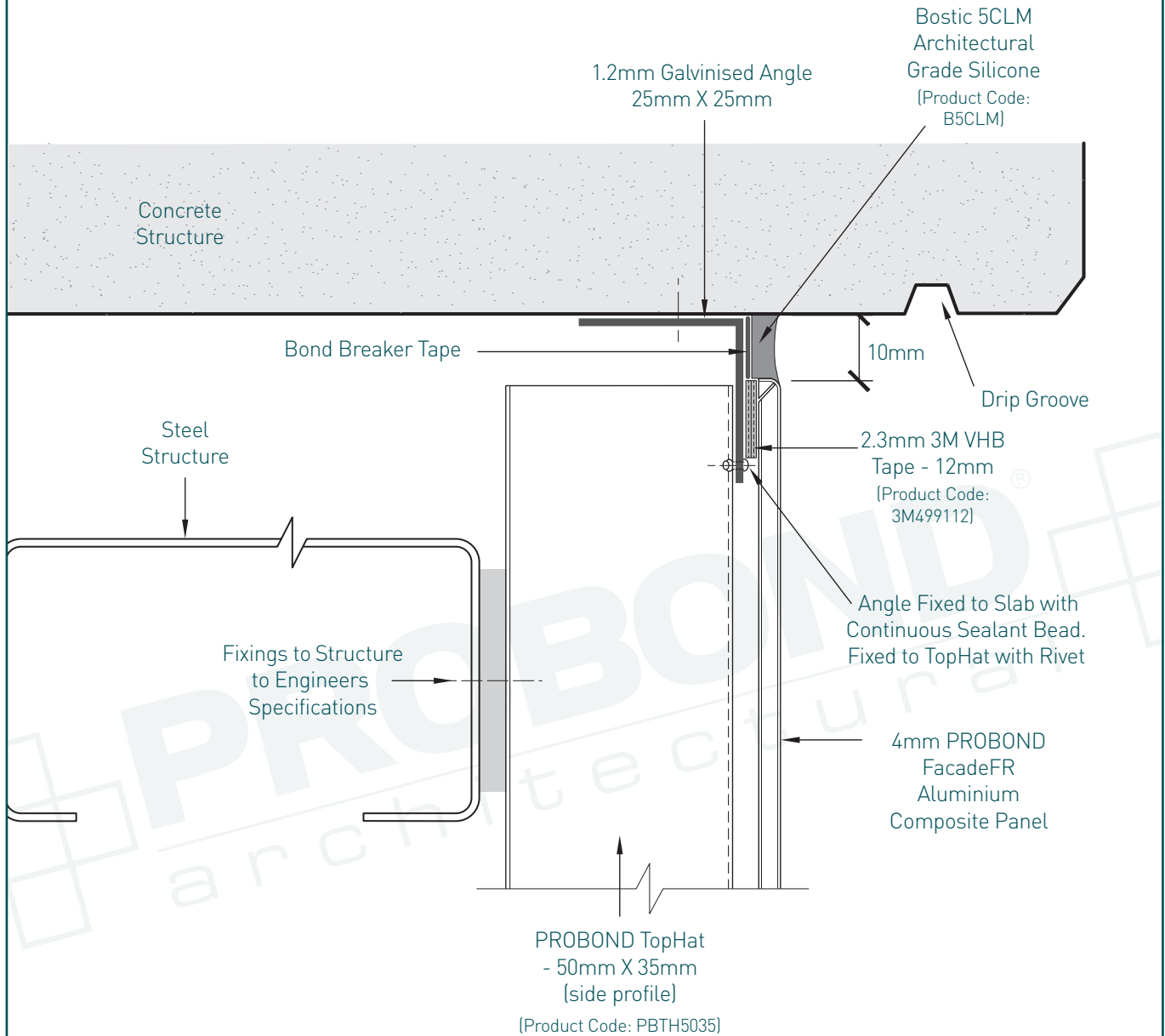

5. Detail at Slab Junction-Head

PROFIX CONCEALED FLAT STICK INSTALLATION - PROBOND FACADE FR

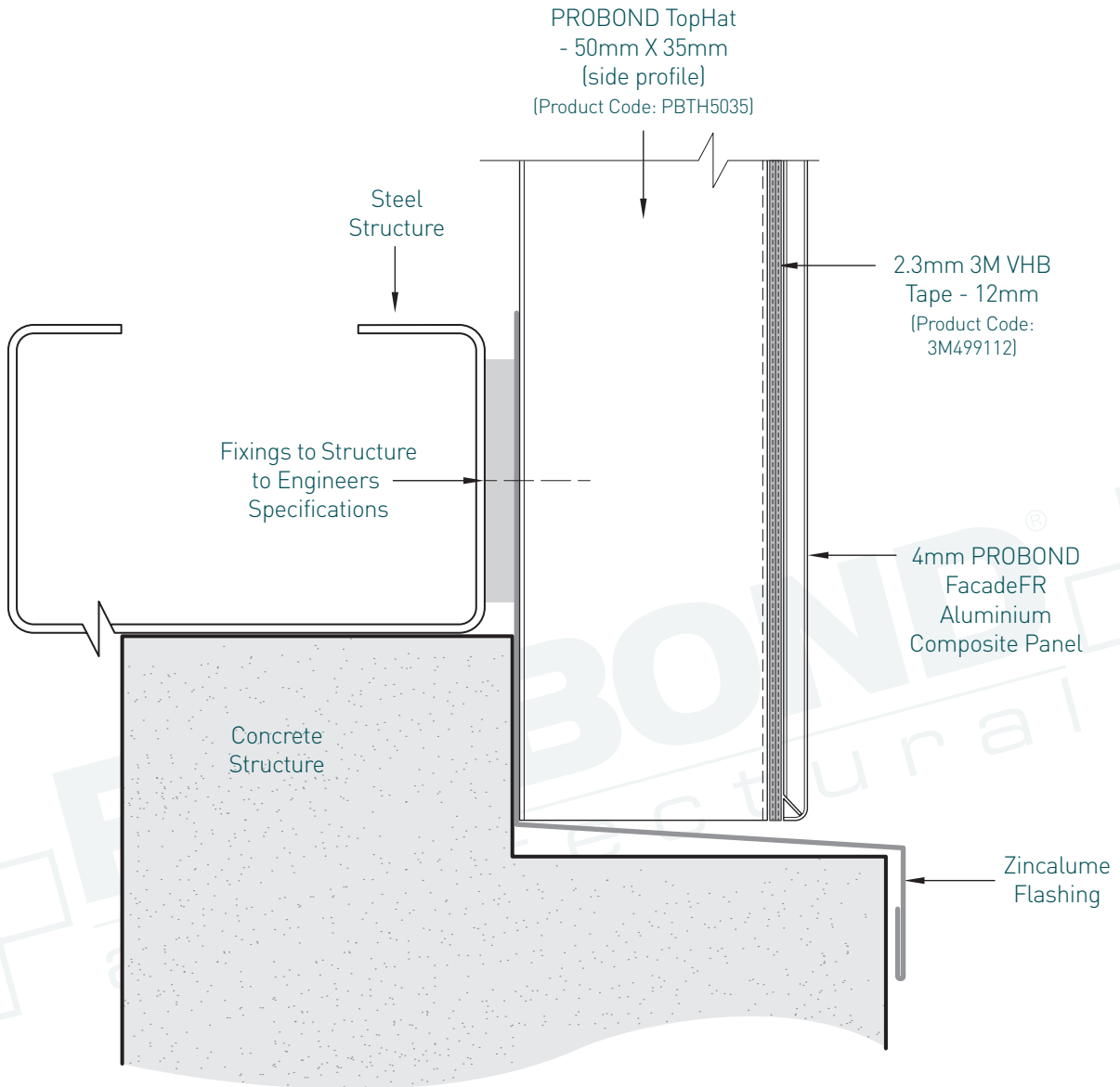

6. Detail at Slab Junction-Base

PROFIX CONCEALED FLAT STICK INSTALLATION - PROBOND FACADE FR

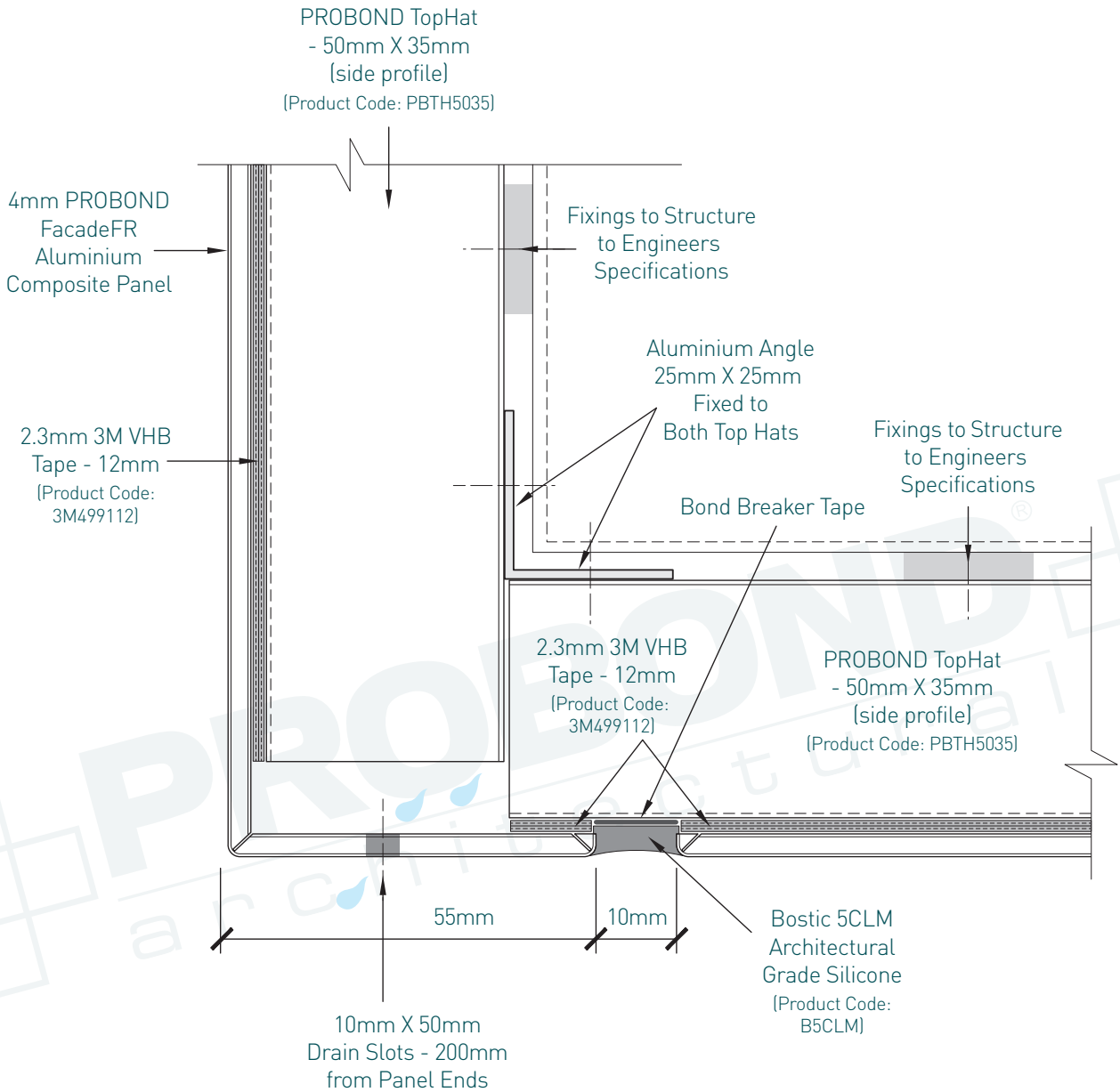

7. Detail at Soffit Junction

PROFIX CONCEALED FLAT STICK INSTALLATION - PROBOND FACADE FR

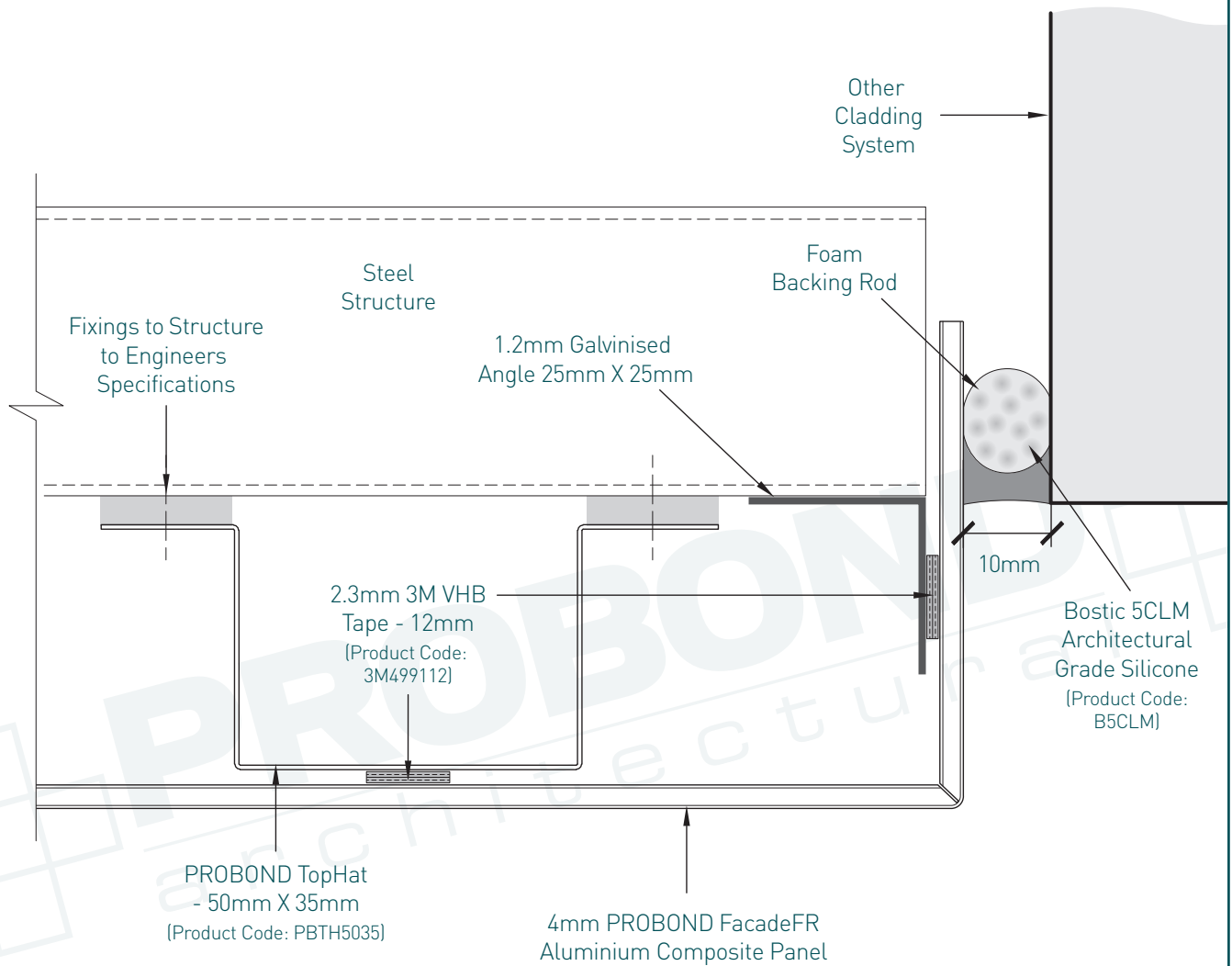

8. Wall Abutment Detail

PROFIX CONCEALED FLAT STICK INSTALLATION - PROBOND FACADE FR

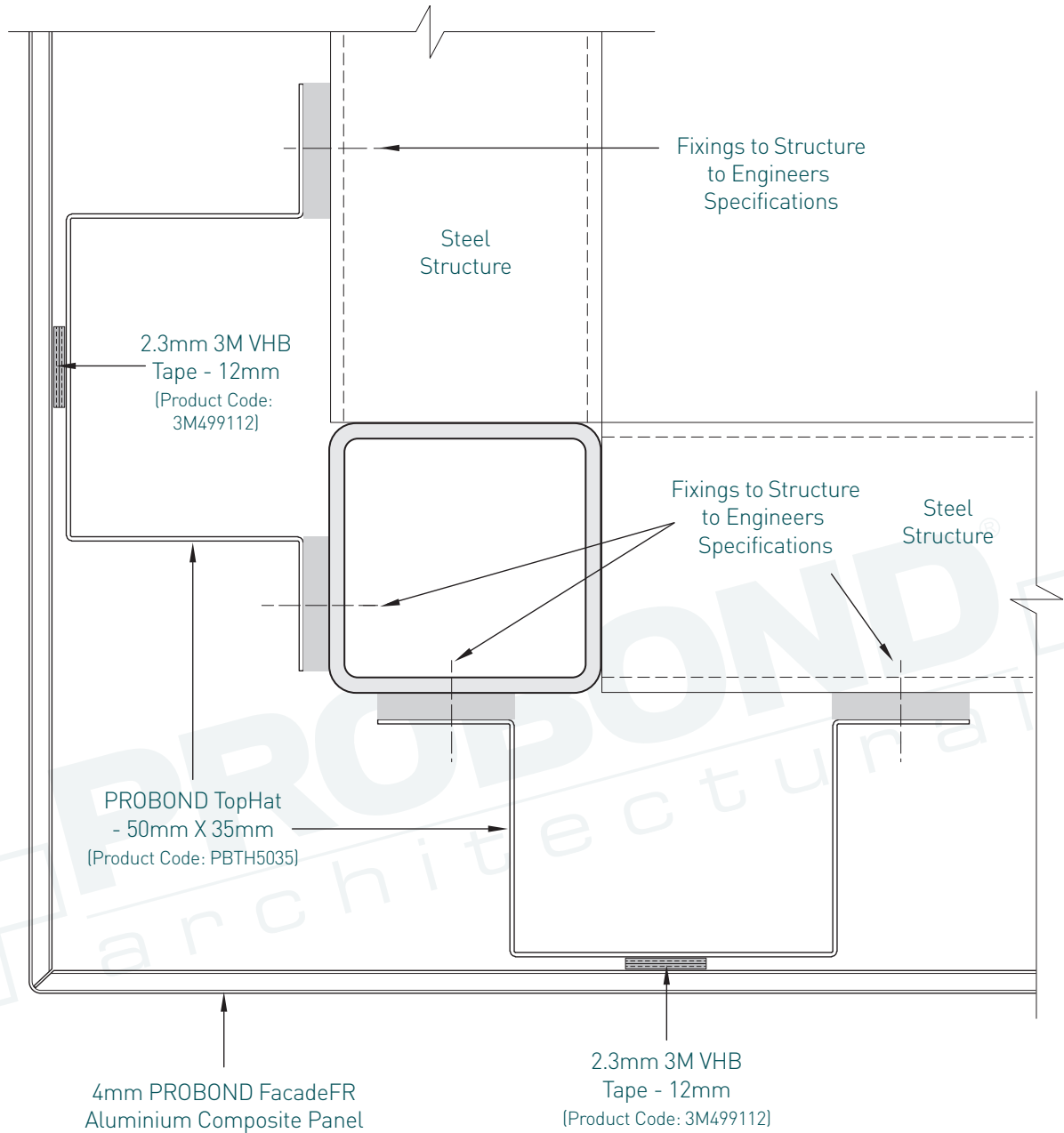

9. External Corner Detail

PROFIX CONCEALED FLAT STICK INSTALLATION - PROBOND FACADE FR

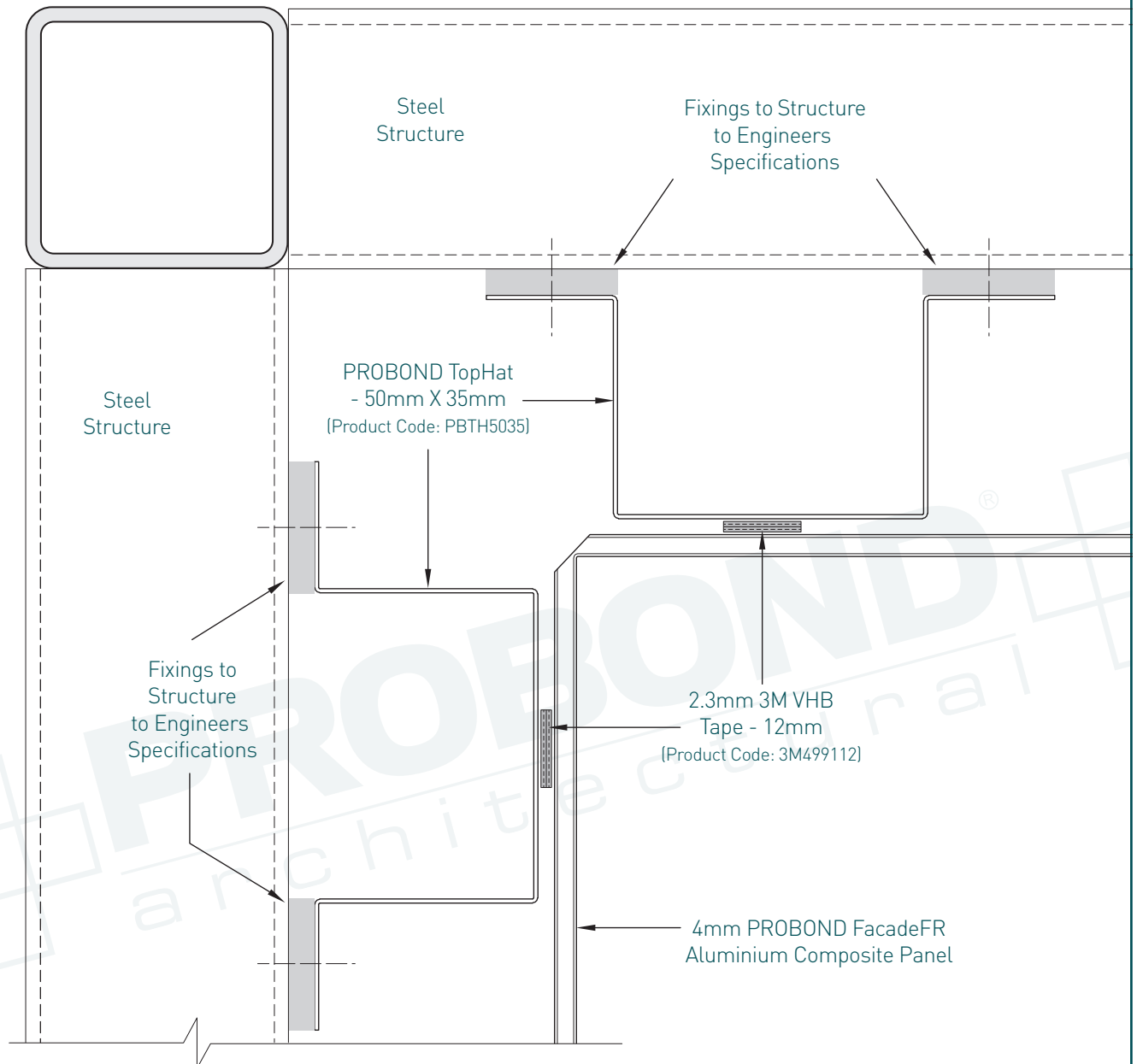

10. Internal Corner Detail

PROFIX CONCEALED FLAT STICK INSTALLATION - PROBOND FACADE FR

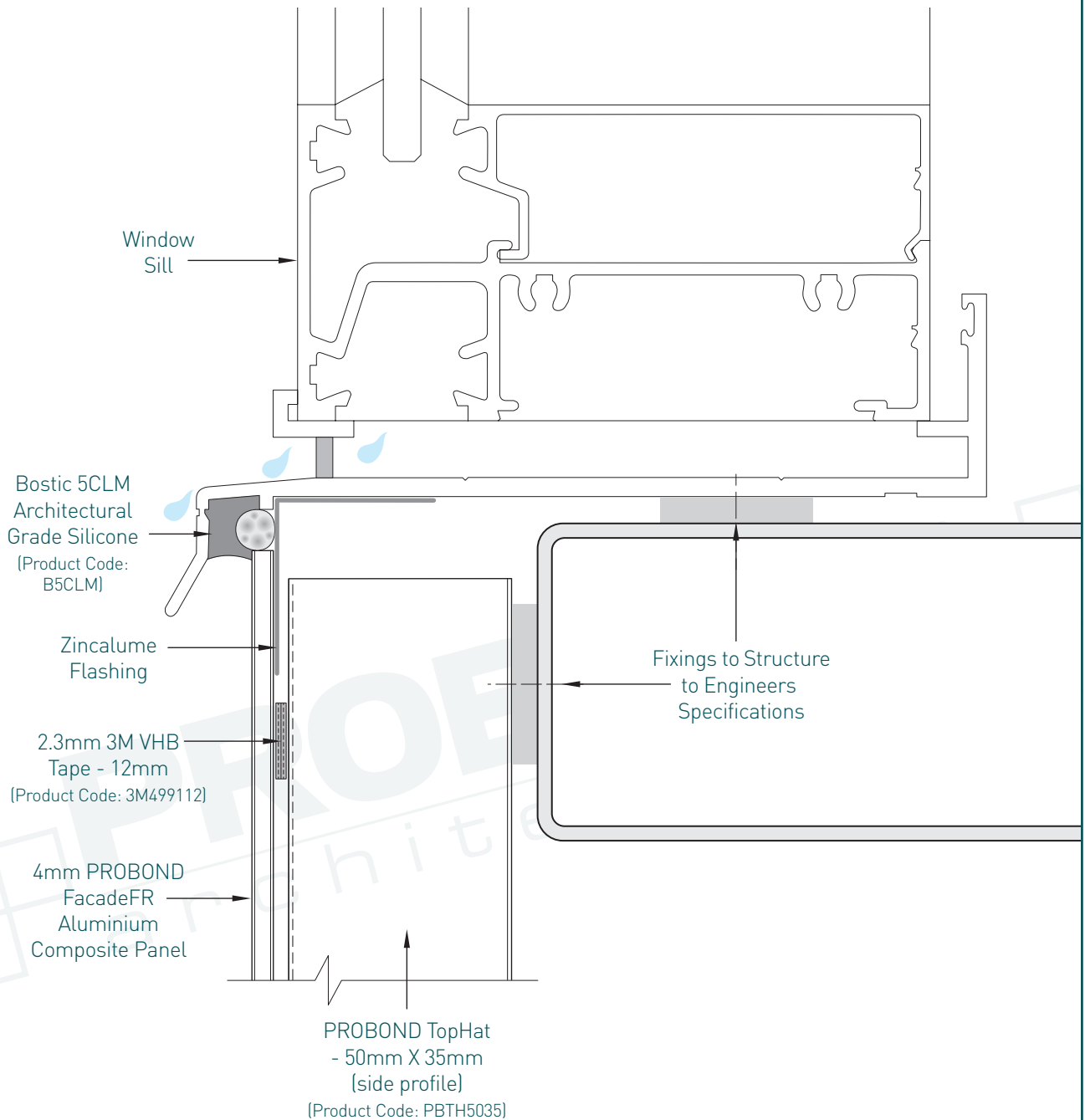

11. Window Sill Detail

PROFIX CONCEALED FLAT STICK INSTALLATION - PROBOND FACADE FR

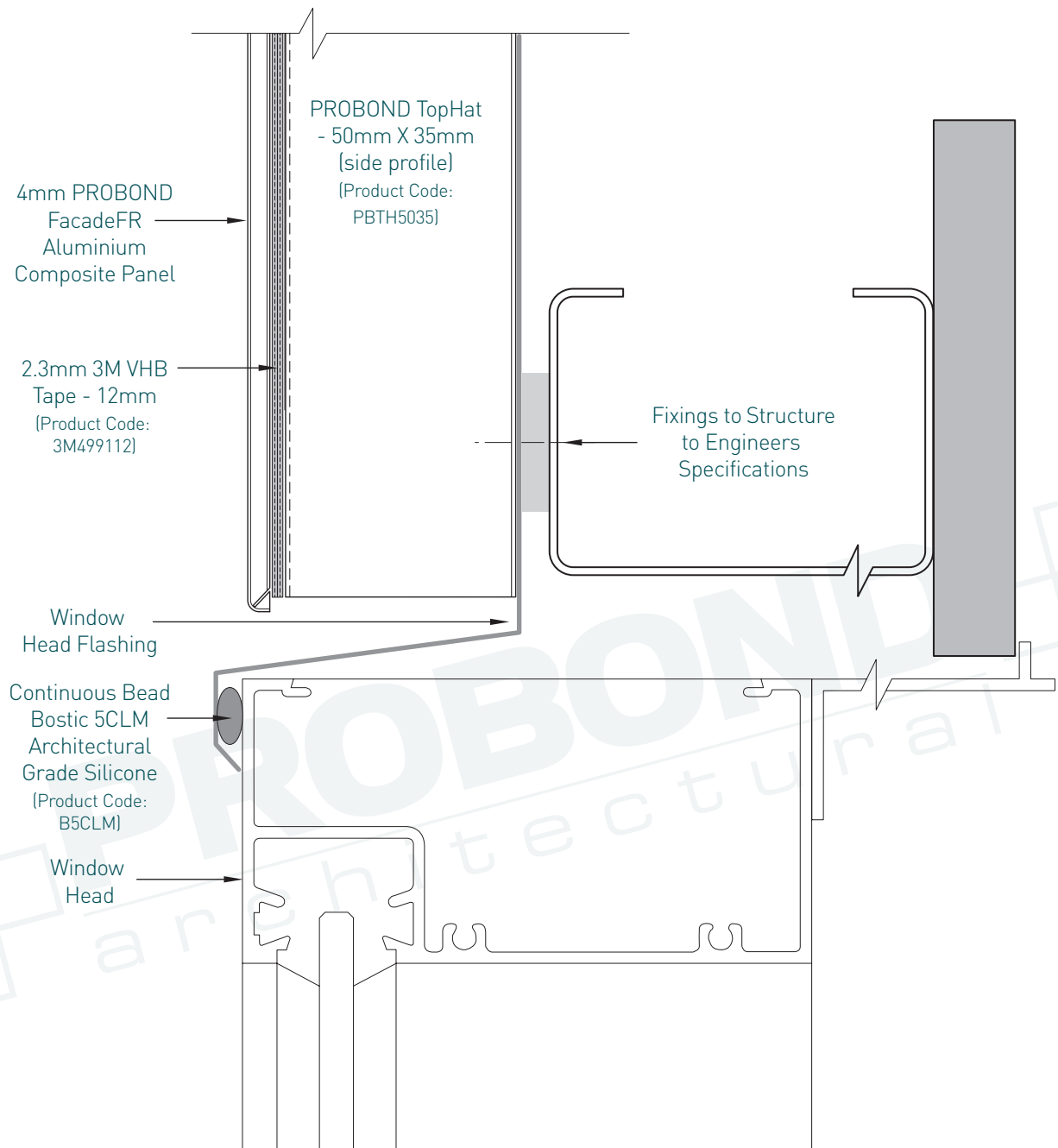

12. Window Head Detail

PROFIX CONCEALED FLAT STICK INSTALLATION - PROBOND FACADE FR

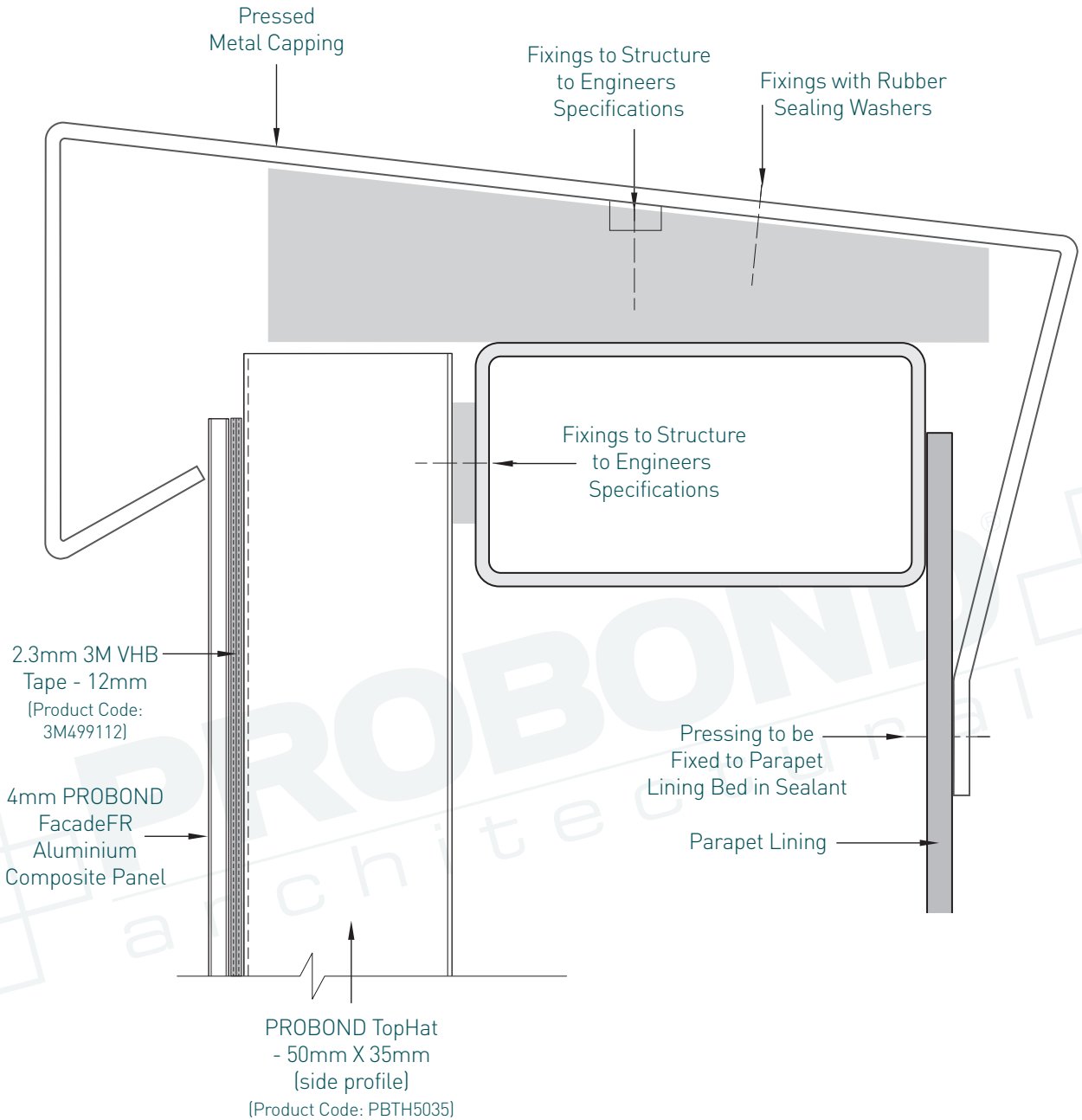

13. Parapet Capping Detail-1

PROFIX CONCEALED FLAT STICK INSTALLATION - PROBOND FACADE FR

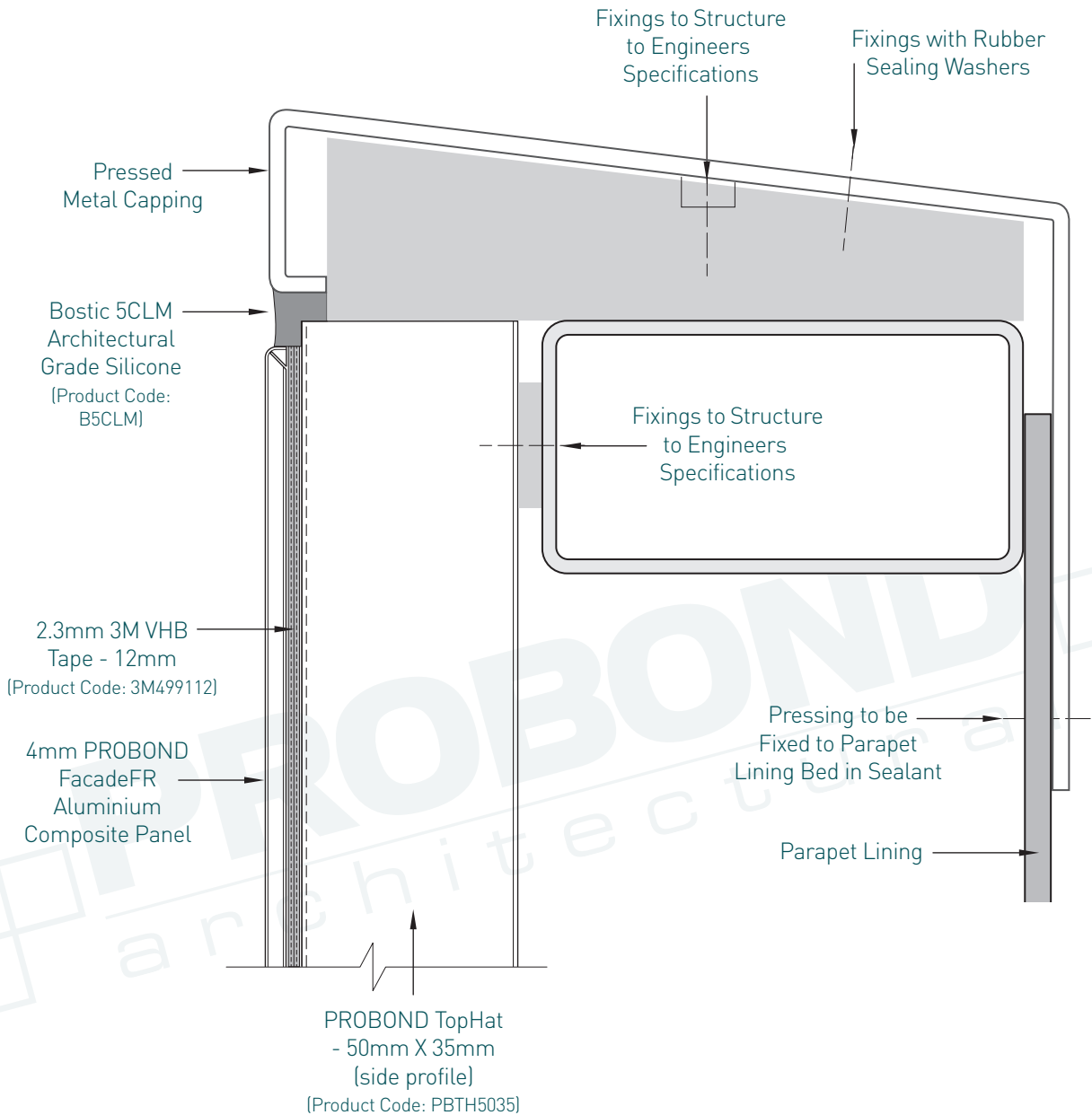

14. Parapet Capping Detail - 2